



TP120-347-RT8-C-DIM-G1-ES

8" Round Commercial 3 CCT & 3 Wattage Selectable

Project: _____

Location: _____

Trim: _____ Qty: _____

Notes: _____

DESCRIPTION

All in one solution 8" round recessed commercial grade LED fixture
Perfect for hospitality, shopping mall & retail, office, exterior soffit, etc.

FEATURES & BENEFITS

- User selectable 3 light colors & 3 power options
- Universal voltage 120V-347V input
- 0-10V Dimmable 5%-100%
- CRI 90+ for true color rendering
- Type IC, Wet location & Air-tight
- Regressed optics with low glare
- Suitable for new construction and retrofit applications

SPECIFICATION	
Applications	Commercial Recessed Ceiling
Power Levels (W)	10 15 22
Light Output (lm)	1000 1500 2000
Color Temperature (K)	3CCT: 3000K - 3500K - 4000K
Beam Angle	90°
CRI	90 +
Input	120V-347V AC 50/60 Hz
Dimming	0 - 10V
Approved Location	Insulated Ceiling & Wet Locations
Air Tight	Yes
Ambient Temperature	-4°F (-20°C) to +104°F (+40°C)
Projected Life	70% Light Output at 50,000 Hours
Certification	cETLus, Energy Star, T24
Warranty	5 Year

DIMENSIONS ID 7 7/8" OD 10 1/4" Regressed 2"
Cut Out 7 7/8" to 9 1/2"

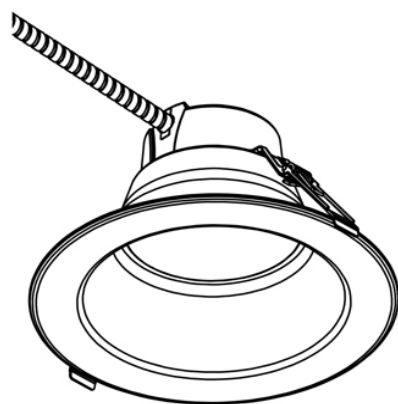
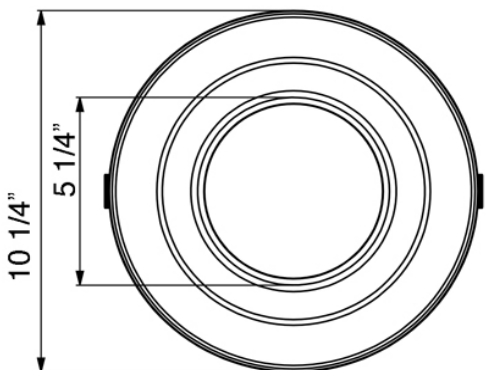
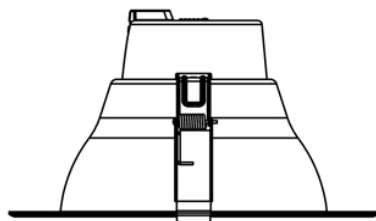
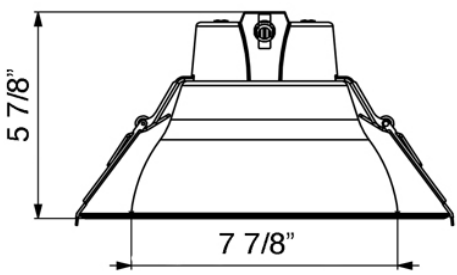
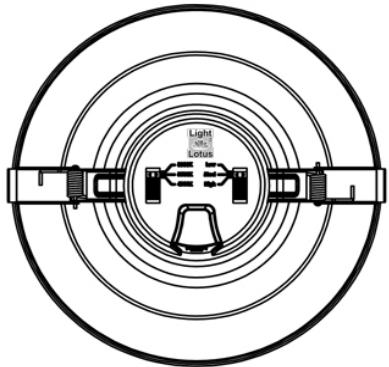

Trim Options

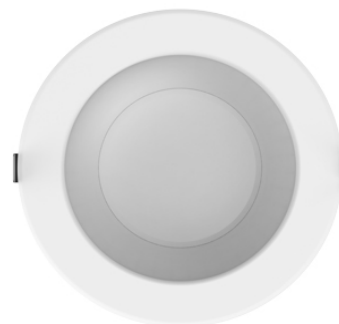

[Matte White](#)

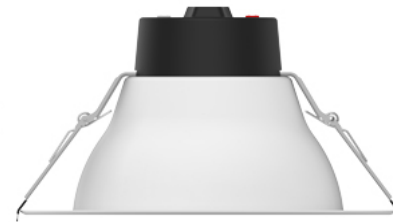

[Alzak \(White Trims & Matte Silver Reflector\)](#)



ACCESSORIES

Sold Separately



Black trim cover model # [LBL-8CRT-B](#)



Silver trim cover model # [LBL-8CRT-S](#)



Goof Ring White OD 12 1/2" model # [LBL-8CGR-W](#)

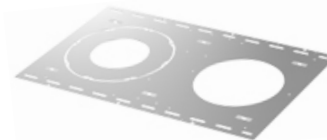

New Construction Mounting Plate for Stud Ceiling
model # [LBL-MP-C4-8-STUD](#)

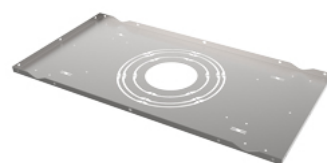

New Construction Mounting Plate for T-bar Ceiling
model # [LBL-MP-C4-10-TBAR](#)

ORDERING GUIDE

TP120-347-RT8-C-DIM-G1-ES
TP120-347-RT8-C-DIM-G1-ES-AZ

Trim / Reflector

[White](#)

[Alzak](#)

COMPLIANCE



Type IC
Air-Tight

Lotus LED Lights USA
250 H Street # 301, Blaine WA 98230 tel 360-200-5500
Hainesport NJ, Naples FL, Vancouver WA

www.LotusLEDLights.com
mailing addresses
warehouses

Lotus LED Lights CANADA
702 Chester Rd, Delta BC V3M 6J1 tel 604-538-3090
Delta BC & Mississauga ON