

Type IC, Wet & Air-Tight



Project: _____

Location: _____

Qty: _____

Notes: _____

DESCRIPTION

Recessed 6" Round LED With Integral Driver In Connection Box.
Fits Where No Other Recessed Fixture Can.

FEATURES & BENEFITS

- 1/2" Thin - Install Directly Under Joists, Maximum Layout Flexibility
- Driver Inside Connection Box - No Junction Box Needed
- Fast & Easy To Install - Save On Labour
- Type IC Rated - No Housing Required
- Dim to Warm 3500K to 2000K
- CRI 90+ for True Colour Rendering
- Wide Trim - No More Goof Rings
- Wet Location Approved

MOUNTING

Cut Hole In Ceiling And Snap Fixture In Opening With Attached Spring Clips.
1 1/2" Above Ceiling Clearance Required For Driver.

| SPECIFICATION | |
|---------------------|-------------------------------------------------------------|
| Applications | Recessed Ceiling, Showers & Soffits |
| Energy Used | 17 W |
| Colour Temperature | 3500 K to 2000 K |
| Light Output | 930 lm |
| Halogen Equivalent | 75 W |
| Beam Angle | 110° |
| CRI | 90 + |
| Driver Input | 120V AC or 277V-347V |
| Power Factor | 0.98 |
| Dimming | TRIAC Dimmers 5% - 100% |
| Approved Location | Insulated Ceiling, Wet Locations |
| Air Tight | Yes |
| IP Rating | IP 54 |
| Ambient Temperature | -40° F (-40° C) to +104° F (+40° C) |
| Projected Life | 70% Light Output at 50,000 Hours |
| Certification | cULus |
| Warranty | 10 Year on Residential 5 Year on Commercial Applications |

DIMENSIONS

ID 6 1/8" OD 7 1/2" Cut Out 6 1/4" to 6 1/2"

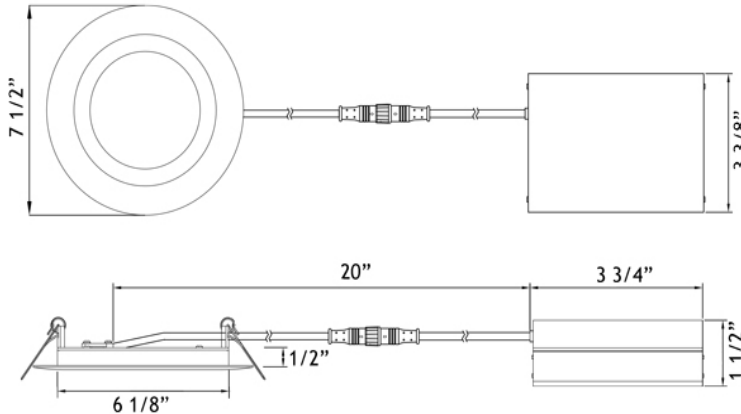

Driver Included

Cable Rating FT4 / CM



Trim Options



White

Black, Brushed Nickel & Brushed Copper
trims available with 90 days lead time

COMPLIANCE



CHARACTERISTICS

Body: Durable, Die Cast Aluminum Alloy for Optimal Heat Dissipation.

Paint: Oil Based Spray Painted - Scratch Resistant And Smooth Finish.

LEDs: 66 Pieces Of Custom Packaged LM80 Epistar 2835. CRI > 90.

Guaranteed 98% Lumen Maintenance After 6,000 Hours.

Strict Binning To Ensure Consistent Light Colour.

Driver: 4th Generation Lotus Designed. Field Proven Since 2011.

Connection Box: Patented Invention By Lotus LED Lights.

Saves Contractors Labour On Installation.

Testing: Every Single Driver Is Powered For Minimum 24 Hours

Together With The Fixture That It Is Shipped With.

Every LED Is Visually Checked Before And After The PCB Is Mounted On The Fixture.

No Random Tests - We Hand Test Every Fixture & Driver.

PHOTOMETRIC DATA OF A LAB TESTED SAMPLE

| | | | |
|----------|----------|--------------------|-------------|
| MODEL: | LL6R-35K | LAMP FLUX: | 932 LM |
| VOLTAGE: | 120 V | LUMENS / POWER: | 54 LM/W |
| POWER: | 17.4 W | CENTRAL INTENSITY: | 356 CD |
| PF: | 0.99 | BEAM ANGLE: | 107 DEGREES |

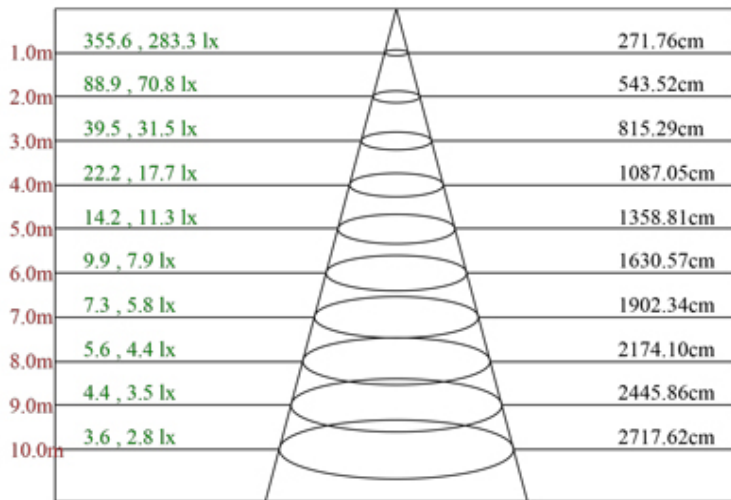

Max , Ave Beam angle of C0plane 107.26

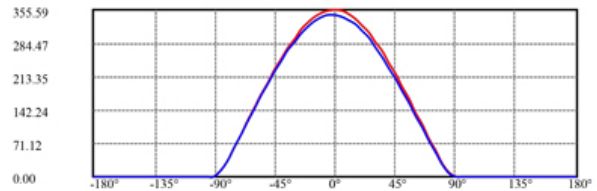
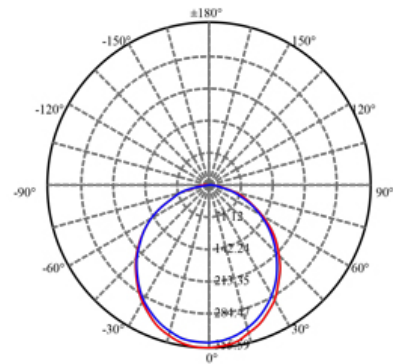

ORDERING GUIDE



Example: LL6R - 35K - WH

LL6R - 35K - Trim Finish * Custom Order
 WH : White
 BK : Black *
 BN : Brushed Nickel *
 BC : Brushed Copper *

Order 277V - 347V Optional Driver Separately As cat # LLL-LD2050H



ACCESSORIES

-  Low Volage Extension Cables
6ft - cat # EXC6, 20ft - cat # EXC20
Max 40 ft Extension Allowed
-  Flanged Rough-In Plates - cat # LRP6
-  Flat Rough-In Plates - cat # RIP612



Warehouses

Vancouver Toronto Las Vegas Naples Philadelphia Dallas Seattle Chicago Denver

tel: 1-844-24-LOTUS (56887) fax: 1-877-561-6306 www.lotusLEDlights.com